

# CircuPool Universal / Si Series

## Troubleshooting Guide

### Table of contents:

Basic Water Chemistry	pg.2
Phosphates & Nitrates	pg.4
Langelier Saturation Index	pg.5
Low Chlorine Level in Pool	pg.6
System Status Menu Displays	pg.9
Troubleshooting	pg.10
How to Clean the Electrolytic Cell	pg.12
How to Install the LCD Display Circuit Board	pg.13
How to Install the Flow Switch	pg.14
How to Install the Temp. Flow Switch	pg.15

The complete Universal or Si manuals are always available at **Circupool.com**:  
<http://www.circupool.com/circupool-userguides.php>

**IMPORTANT** - REMEMBER THAT YOUR POOL IS COMPATIBLE WITH CHLORINE AND SHOCK AS NORMAL. IF YOUR POOL IS EXPERIENCING TEMPORARY LOSS OF CHLORINE OR OTHER DIFFICULTIES, ADD SANITIZER AS NEEDED TO MAINTAIN THE POOL.

**WARNING** - ALWAYS MAKE SURE THE INPUT POWER IS COMPLETELY DISCONNECTED BEFORE ATTEMPTING ANY TROUBLESHOOTING PROCEDURES. ALL TROUBLESHOOTING SHOULD BE DONE BY A QUALIFIED PROFESSIONAL.

## BASIC WATER CHEMISTRY

Managing the water chemistry of your pool is critical for effective chlorination and ensuring the safety of swimmers in the pool and preventing damage to your pool materials and equipment. This guide reflects national standards for pool water chemistry; for in-depth assistance, please consult your local pool professional and provide them with a copy of your manual in order to ensure that they are familiar with your specific pool equipment.

**\*Helpful Tip:** *The Pool Calculator App* takes care of all of the math that might come up when keeping your swimming pool's water chemistry in balance. It is able to tell you exactly how much of each chemical to add. Visit [www.poolcalculator.com](http://www.poolcalculator.com)

	<u>Swimming Pools</u>	<u>Spas</u>
<b>Free Available Chlorine</b>	1.0 - 3.0 ppm	3.0 - 5.0 ppm
<b>Salinity</b>	3000 - 4000 ppm	3000-4000 ppm
<b>pH</b>	7.2 - 7.8	7.2 - 7.8
<b>Stabilizer (Cyanuric Acid)</b>	50 - 75 ppm	50 - 75 ppm
<b>Total Alkalinity</b>	100 - 200 ppm	100 - 200 ppm
<b>Calcium Hardness</b>	200 - 400 ppm	150 - 450 ppm
<b>Saturation Index</b>	-0.2 to +0.2 (0 best)	-0.2 to +0.2 (0 best)
<b>Phosphates</b>	0 to 100 ppb (0 best)	0 to 100 ppb (0 best)
<b>Nitrates</b>	0 to 10 ppm (0 best)	0 to 10 ppm (0 best)
<b>Metals</b>	0	0
<b>Ammonia</b>	0	0

### Chlorine

Measurable chlorine shows the level of disinfecting chlorine available to keep your pool sanitary. Chlorine is consumed by sunlight, and by breaking down organic material in your pool. The level of chlorine you need to maintain depends on your CYA level and how much you use the pool. It is important that you do not allow chlorine to get too low, or you run the risk of getting algae or germs. Maintaining an appropriate chlorine level is the most important part of keeping your water in balance. The chlorine level should be between 1.0-3.0ppm. It can be efficient to raise the chlorine level in the evening, since none will be lost to sunlight until the next morning. Without constant supply, the chlorine level goes down by itself. If you must lower the chlorine level quickly, you can manually turn off your salt system at any time.

### Salt

This level will typically be around 3,500. This level is less than one tenth of the salt level in ocean water, which has around 35,000ppm of salt.

Salinity can be raised by adding salt sold for use in pools water softeners (sodium chloride). Ensure that the salt is 99.8% pure or better, and which doesn't have any rust inhibitor or other additives. Crystals are fine, pellets will work but dissolve slowly.

### CYA - Cyanuric Acid

Cyanuric acid, often called stabilizer or conditioner, both protects chlorine from sunlight and lowers the effective strength of the chlorine. If you don't have problems from extremely high amounts of sunlight, CYA is typically kept between 30 and 50. If you have a salt system or very high levels of direct sunlight, CYA is typically kept between 70 and 80.

**pH - Acidity/Alkalinity**

pH indicates how acidic or basic the water is. pH should be tested daily at first. Once you gain experience with your pool, less frequent monitoring may be appropriate, depending on your pool's typical rate of pH change. pH levels between 7.5 and 7.8 are ideal, while levels between 7.2 and 7.8 are acceptable for swimming.

**TA - Total Alkalinity**

Total alkalinity indicates the water's ability to buffer pH changes. Buffering means you need to use a larger quantity of a chemical to change the pH. At low TA levels, the pH tends to swing around wildly. At high TA levels, the pH tends to drift up. TA contributes to the LSI which indicates the tendency for plaster damage or calcium scaling.

You can raise TA with baking soda. It is often best to make large TA adjustments in a couple of steps, testing the water after each one, as adding baking soda will also affect the pH and you don't want the pH going out of range.

**CH - Calcium Hardness**

Calcium hardness indicates the amount of calcium in the water. A plaster pool should have CH levels between 250 and 350 if possible. If you have a spa you might want to keep CH at at least 100 to 150 to reduce foaming. CH contributes to the LSI which indicates the tendency for plaster damage or calcium scaling. You increase CH with calcium chloride, sold as a deicer and by pool stores, or calcium chloride dihydrate, sold by pool stores for increasing calcium. You lower calcium by replacing water or using a reverse osmosis water treatment.

See following **Basic Water Chemistry** pages for more specific information about **Phosphates, Nitrates, and Saturation Index (LSI)**

## BASIC WATER CHEMISTRY - PHOSPHATES & NITRATES

**Phosphates are a part of the environment:** Phosphates became a household word in the 1970's. This is when people started to use low-phosphate and phosphate-free laundry detergents to help minimize the detrimental effects of excess phosphates in lakes, streams, wetlands and other runoff areas- effects such as unwanted algae blooms.

**Phosphates accumulate in pools:** What's true for lakes is also true for swimming pools; there are innumerable ways phosphates can get into your pool. Phosphates are a natural component of most swimmer wastes. It is also present in rain water. It can be blown in on the wind, in dirt or dust, or in plant material that enters the pool. It may also be introduced by landscaper's fertilizers at very high levels, which may blow into the pool or come in from water runoff. Phosphate levels are persistent and do not break down naturally- you have to treat the water to remove phosphates. For all of these reasons, pools can quickly build up phosphate levels. This can lower chlorine levels and create an abundant source for all strains of algae & microorganisms, and can make controlling their growth difficult. Remove the food source, and you can normalize chlorine demand and have a strong weapon against algae.

**When phosphates are present, chlorine levels go down and algae grows:** Phosphate is the main ingredient in fertilizer. Phosphate is plant food, and algae are plants. If you have had persistent trouble with chlorine levels or algae, you may have a phosphate problem in your pool. When excess phosphate is present in a swimming pool, the symptoms often include the following: Quickly Dissipating Chlorine Levels or Excessive Chemical Consumption; Cloudy, Green Water; Slippery and Slimy Surfaces; Mustard and Green Colored Debris; Poor Water Quality.

**Remove the phosphates and solve the problem:** It only takes tiny amounts of phosphates to become significant in pools. The maximum level of phosphate in pool water should be less than 100 ppb, as close to 0 as possible. Once the phosphates climbs above this level, the water quality begins to decrease. Fortunately, draining to eliminate the accumulated phosphate is no longer necessary. Phosphate removers can be added which allow the phosphates to be removed from the water. A popular choice is Natural Chemistry's Phos-Free, which is a natural mineral product and is non-toxic.

You can test for phosphates in your pool with the AquaChek Phosphate Test Kit found at [www.aquachek.com](http://www.aquachek.com)

**Nitrates:** Nitrates are a matter similar to Phosphates, but of different origin; however both a food source for algae. Nitrate is a plant nutrient and is present in all green plants and fertilizers. It is natural occurring and is found everywhere something is growing. Nitrites (NO<sub>2</sub>) are a close cousin to Nitrates (NO<sub>3</sub>) and are just as much of a problem for pools, because when a Nitrite comes in contact with water, it easily gains another Oxygen atom to become a Nitrate. This additional atom gives Nitrates real stability, and makes eradication difficult. In fact, the only known way of Nitrate removal in pools practiced today is to drain a portion of the pool, and refill with water that is Nitrate free, if possible. Shocking a pool heavily will revert the Nitrates back to Nitrites, but can easily revert once again as an additional Oxygen atom is easy to come by in a swimming pool filled with H<sub>2</sub>O.

**Where do Nitrates come from?** Rural areas - those with water wells and septic tanks are particularly prone to Nitrate contamination in pools. Fertilizer is the most common source of Nitrates in pools. Animals that enter the pool, as well as birds spend time above the pool, can become a significant source of contaminants. Rain spilling off of overhanging trees can add Nitrates to a pool, and even acid rain itself, so common in the Northeast, can increase Nitrate levels. Finally, human waste, sweat, cosmetics can all bring traces of Nitrates into the pool. At levels as low as 10ppm of Nitrate, algae will grow even though you have used algaecide and are keeping a proper chlorine residual. But keeping a proper residual of chlorine in the water can prove to be difficult when Nitrates are present. This is what tricks people into believing in Chlorine Lock- it's not blocking chlorine, but using it very quickly.

**What can be done to Eliminate Nitrates in my pool?** There still however is no chemical to remove the Nitrates from the pool water, so if you have a contamination, you will need to drain most if not all of the pool water.

## BASIC WATER CHEMISTRY - LANGEIER SATURATION INDEX (LSI)

LSI is a measurement of the water's ability to absorb and hold solids in a solution. It is important to know that the scale on which LSI is measured is very narrow, meaning that a small change can indicate a significant difference in your pool. Like pH, the LSI value is logarithmic, meaning that a difference of 1.0 equates to a difference of ten times in reality. A Saturation Index of -2.0 is ten times more corrosive than an SI of -1.0. This is important, as many pool equipment manufacturers may not be able to warranty damage caused by an out-of-balance LSI.

### STEPS TO TAKE:

1. Obtain a complete water chemistry test from a pool store for the following items:

pH, Water Temperature, Alkalinity, Cyanuric Acid (Stabilizer), Calcium Hardness, Total Dissolved Solids

2. Go to [www.aquachek.com](http://www.aquachek.com)

- a. Click on "Calculators"
- b. Click on "Langelier Saturation Index"
- c. Plug in your results and obtain your Saturation Index number.

3. Go to [www.poolcalculator.com](http://www.poolcalculator.com) to balance your water accordingly.

**If LSI Index is between -0.2 and +0.2 pool water is Balanced.** When pool water is balanced, it has no effect on the pool or equipment. There are two values you can readily change to help improve your LSI value to get it into the optimum range: pH and Alkalinity level.

**If LSI Index is less than -0.2 pool water is Corrosive.** Pool water may cause etching, pitting, dissolving and staining of walls, grouting and plumbing. It will also cause erosion to the titanium salt cell.

- As Stabilizer Increases, LSI Decreases
- As Total Dissolved Solids Increase, LSI Decreases

To raise your LSI value, you should first balance the calcium hardness in the pool. It needs to be between 200-400 PPM at all times. If the calcium hardness is in the correct range, add sodium bicarbonate or baking soda. Consult the calculator at [www.poolcalculator.com](http://www.poolcalculator.com) to determine the target Alkalinity value (recommended range is 80-120ppm; however, you may find that a level lower than 80 may be ideal for a balanced LSI value).

**If LSI Index is greater than +0.2 pool water is Scale Forming.** Pool water may deposit excess minerals on the pool and equipment. Scale generally appears as white or lightly colored rough blotches on the pool walls. It also adheres to other objects in the pool, piping and filter system. This will cause calcium deposits to rapidly form on the titanium salt cell. Scale can restrict water flow, shortening filter runs and reducing filtration efficiency.

- As Temperature Increases LSI Increases
- As Total Alkalinity Increases LSI Increases
- As pH Increases, LSI Increases
- As Calcium Hardness Increases, LSI Increases

To lower your LSI value, you should first consider adding muriatic acid (can be found in pool supply stores), as it is more difficult to lower Calcium Hardness and especially temperature. Consult the calculator to determine the target pH value.

## LOW CHLORINE LEVEL IN POOL

**IMPORTANT** - REMEMBER THAT YOUR POOL IS COMPATIBLE WITH CHLORINE AND SHOCK AS NORMAL. IF YOUR POOL IS EXPERIENCING TEMPORARY LOSS OF CHLORINE OR OTHER DIFFICULTIES, ADD SANITIZER AS NEEDED TO MAINTAIN THE POOL.

**IMPORTANT:** Measuring a low chlorine level does not indicate that your system is not working. Water chemistry and environmental conditions are the #1 cause of a low chlorine level in a saltwater pool. The following steps will enable you to verify with certainty whether or not your system is operational and creating chlorine. Following that, this help guide will help identify what may be contributing to the low chlorine level in the pool water.

### Verifying that the system is operational

There are two variables involved in the generation of chlorine: salt and electricity. If there is salt in the water and power being sent to the Electrolytic Cell, the system is generating chlorine normally. If the salt level is in question, independently test a water sample.

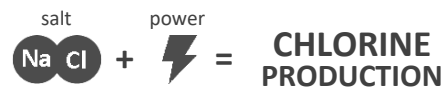

### Verifying Power is present in Cell

1. Ensure no Warning Lights are on
  - Is the No Flow LED indicator illuminated solidly? If it is, the system is not able to send power through the cell because the Flow Switch is not being triggered by the flow of water.
  - Is the Check Cell LED indicator illuminated solidly? If it is, the system is not able to send power through the cell because of excess mineral build-up inside of the cell.
  - Is the High Salt or Check Salt LED indicator illuminated solidly? If it is, the system is not able to send power through the cell because of improper salinity levels. If the Check Cell light is also on, the Check Cell light takes priority.
  - Is the Generating LED indicator flashing? If it is, the system is not able to send power through the cell because the water temperature is outside of operating range.
2. Confirming Cell Current
  - If all warning lights are off, power is successfully able to pass through the cell. The Control Module has a built-in power meter that ensures that the full and complete amount of power is able to pass through the cell.
  - To verify the power being sent through the cell, turn the chlorine output setting up to 100% for diagnostic purposes. To access the power reading in the menu, press the System Status button (to the left of the screen) three times to display the "Cell Current" reading. As long as the "Cell Current" reads above zero when turned up to 100%, the system is at that moment able to pass full amount of power through the Cell, and is fully operational and creating chlorine normally.

**Summary:** If salt is present above the minimum level of 3000 ppm, if the warning lights are not illuminated solidly, if the Generating LED indicator is illuminated solidly, and if "Cell Current" reads above zero when the system is turned up to 100%, then the system is fully operational and creating chlorine normally. If a low chlorine level persists after continued operation, see the next pages to troubleshoot common causes of high chlorine demand.

## LOW CHLORINE LEVEL IN POOL (Continued)

### Common Causes of Low Chlorine Levels

#### Examine the Water Chemistry (Also see Page 2):

- Water chemistry and environmental conditions are the #1 cause of a low chlorine level in a saltwater pool, as they cause chlorine demand to rise above normal levels. **High chlorine demand** means that chlorine is being consumed quicker than it is being replenished, resulting in the inability to measure the chlorine residual in the water. If operation has been verified (as described on the previous page), this *does not mean* that the chlorine generator is not working, only that the chlorine demand currently exceeds the rate of chlorine production.
- The ideal levels for a salt water pool are

	<b>Free Available Chlorine</b>	1.0 - 3.0 ppm
	<b>Salinity</b>	3000 - 4000 ppm
	<b>pH</b>	7.2 - 7.8
➔	<b>Stabilizer (Cyanuric Acid)</b>	50 - 75 ppm
	<b>Total Alkalinity</b>	100 - 200 ppm
	<b>Calcium Hardness</b>	200 - 400 ppm
	<b>Saturation Index</b>	-0.2 to +0.2 (0 best)
➔	<b>Phosphates</b>	0 to 100 ppb ( <u>0 best</u> )
➔	<b>Nitrates</b>	0 to 10 ppm ( <u>0 best</u> )
	<b>Iron</b>	0
	<b>Copper</b>	0
	<b>Other metals</b>	0
	<b>Ammonia</b>	0

The levels that are highlighted levels are the most common causes of high chlorine demand and depleted chlorine levels in pools. Ensure that all three levels are being tested for and that their values are included on your chemistry report.

The **Chlorine Stabilizer** (Cyanuric Acid, or CYA) level must be within range, especially during the spring and summer months. If there is not enough CYA in the pool, then your chlorine will not be protected from the sun and the chlorine being produced by the salt system will be consumed once the sun hits the pool water. Up to 90% of the pool's chlorine can be depleted within 2 hours without a sufficient level of chlorine stabilizer.

**Phosphates** and **Nitrates** that are present in the pool will cause the chlorine demand to rise and/or will consume the chlorine being made by the salt system (Also see page 4). Phosphates are very common. Any Phosphate level near or above 100 parts per billion can greatly increase the chlorine demand in the pool. Any Phosphate level over 200 Part Per Billion will not only consume your chlorine, it will also readily feed algae. To remove phosphates, use commercial grade Phosfree. When trying to lower significant phosphate levels, phosphate products meant for weekly maintenance are usually not effective. Nitrates will also rapidly consume your chlorine. If the Nitrate level is high, it is often most effective to drain the pool and refill with new water, being sure to add the necessary amount of salt back to the pool.

Lower salt levels can affect chlorine generation and cause the system to work inefficiently.

Other chemistry imbalances and the presence of metals, ammonia, and other impurities can cause high chlorine demand.

## Common Causes of Low Chlorine Levels (Continued)

### Insufficient Operation:

- **Ensure input power**- Is the salt system turning on and off with the pump as normal? Has the fuse been tripped? If so, see "No Power", page 9.
- **Output Level** - The percentage output level that you set tells the system how much of its maximum capacity to use in order to create chlorine. If you are experiencing high chlorine demand, ensure that you have your system turned up to 100% output so that it is doing as much as possible to compensate. Leave the system at 100% output until the pool is balanced again. Since every pool operates differently and has a different level of chlorine demand, during normal operation there is not a standard percentage level at which to set the output.
- **Run time** - When sized right, a chlorine generator can typically achieve sufficient chlorination when run on the filter pump's normal schedule. However, every pool has different equipment and its operation is unique, and you may require (or choose) to run the filter pump more or less than is standard. As a rule of thumb however, run your system one hour for every ten degrees of ambient temperature in order to achieve both sufficient filtration and chlorination. Periods of high use, harsh environmental conditions, or excessive chlorine demand may require extended run times. For example, running your system twice as long will allow it to create twice as much chlorine.
- **Cell Maintenance** - Make sure the cell plates are clean and free from any debris. The Self-Cleaning feature minimizes the amount of mineral deposits that will occur, but as with every salt system, the electrolytic cell should be cleaned periodically. If there are any calcium deposits or debris that may have made it past the filter (hair, grass, etc...) which are causing the cell plates to bridge together, clean the cell with one part muriatic acid and five parts water for 10 minutes. If the cell plates need to be cleaned the CHECK CELL light will most likely be illuminated.
- **During initial startup** (springtime / new pools) - When being opened, pools typically have much higher than normal chlorine demand. In these circumstances a pool requires a large amount of sanitizer all at once, which means that it is often more effective to add chlorine or shock as needed initially instead of waiting on the system to slowly reach "break-point" chlorination.



## System Status Menu Displays

This information is also printed on the inside of the door of your control module for easy reference.

### 0. Average Salinity (Default Display)

This reading slowly changes as the system continues to collect salinity readings in real-time throughout its operation. When first installed, this will display the salinity that was detected while testing at the factory. This reading may show lower than actual salinity levels if the system has had any LED lights illuminated for a time, and will slowly return to normal when the LED lights have turned off after the issue has been resolved.

### 1. Pool Temperature

Working temperature is 60°F-140°F. While displayed, can be changed to °C by moving the Super Chlor switch from the middle position to the left position.

### 2. Cell Voltage

Range can be 20.0-26.0 volts (while generating). If the voltage reads near 10.0-13.0, the system is configured to accept 220V but is only receiving 110V.

### 3. Cell Current

Range can be 2.50-8.00 amps (while generating). May be 0 during normal operation when system turned to less than 100% output and is in its rest mode. If present, a hyphen (-) indicates polarity, and not a negative value.

### 4. Desired Chlorine Output

0P - 100P, percentage of maximum chlorine output set by user.

### 5. Instant Salinity

Real-time salinity test result in XXXX PPM. While displayed, can be changed to X.X g/L by moving the Super Chlor switch from the middle position to the left position. May display zeros while in rest mode or when LED lights are illuminated. If present, a hyphen (-) indicates polarity, and not a negative value.

### 6. Product Item

May vary, not a changeable option.

### 7. Software Revision

May vary, not a changeable option.

### 8. Cell Version

May vary with production and cell version.

## Troubleshooting

**WARNING** - ALWAYS MAKE SURE THE INPUT POWER IS COMPLETELY DISCONNECTED BEFORE ATTEMPTING ANY TROUBLESHOOTING PROCEDURES. ALL TROUBLESHOOTING SHOULD BE DONE BY A QUALIFIED PROFESSIONAL.

### 1. Check Cell LED light is flashing:

- a. Inspect inside of cell for debris or mineral deposits, clean if necessary. Hold down the System Status button for 5-10 seconds to reset the light.

### 2. Check Cell LED light is on solid:

- a. This takes priority over Check Salt / High Salt lights. Cell efficiency has been greatly reduced and the cell must be cleaned. If you are needing frequent cleanings, the pool has a high Saturation Index, see page 5.
- b. Ensure salinity is in range, ideally 3000-4000 PPM.
- c. Ensure correct Cell Version is set in the System Status menu.
- d. Ensure Si voltage configuration matches input voltage.
- e. Low speed pump does not have enough flow to clear air and gas from the Cell. This is often the case if the appearance of the Check Cell light corresponds with pump operation, pump timer, or daily schedules. Invert cell.

### 3. Check Salt / High Salt LED light is flashing:

- a. The detected salinity level is approaching minimum / maximum limits. Operation will continue, but take steps to ensure the salinity stays in range.

### 4. Check Salt / High Salt LED light is on solid:

- a. The detected salinity is outside of the system's operating range, and the system has ceased operation.
- b. Check Cell takes priority over Check Salt / High Salt lights.
- c. Ensure correct Cell Version is set in the System Status menu.

### 5. No Flow LED light is flashing:

- a. The system has detected that water flow has been restored, and is ensuring constant and steady flow. This light may blink for 30-60 seconds after flow has been restored.

### 6. No Flow LED light is on solid:

- a. The Flow Switch is not being triggered by water movement.
- b. Ensure that the Flow Switch cord is connected to the bottom of the Control Module.
- c. Ensure that the return line has pressure and the water flow rate exceeds 25 gpm.
- d. Ensure that the Flow Switch itself is facing the correct direction in the plumbing. Refer to the arrow on the top of the sensor for reference, make sure the arrow is pointing in the same direction as the water flow.
- e. Ensure that the Flow Switch has not been installed too near to an angled pipe union or change in direction in the plumbing. The manual specifies at least 6-12" of straight pipe before the water enters the Flow Switch.

### 7. Instant Salinity and Cell Current read zero:

- a. This will occur during the system's normal rest cycle when the chlorine output level is set to less than 100%.
- b. If any warning lights are illuminated solidly, the system will stop sending power through the cell.
- c. Ensure Si voltage configuration matches input voltage.

**WARNING - ALWAYS MAKE SURE THE INPUT POWER IS COMPLETELY DISCONNECTED BEFORE ATTEMPTING ANY TROUBLESHOOTING PROCEDURES. ALL TROUBLESHOOTING SHOULD BE DONE BY A QUALIFIED PROFESSIONAL.**

### 8. No power to Control Module:

- The fuse has been blown and needs to be replaced. Every unit comes with a spare fuse located inside the front door of the control box. The 15 AMP fuse is available at RadioShack or any auto parts store. The fuse is located inside the control panel directly to the left of the display screen (see below)

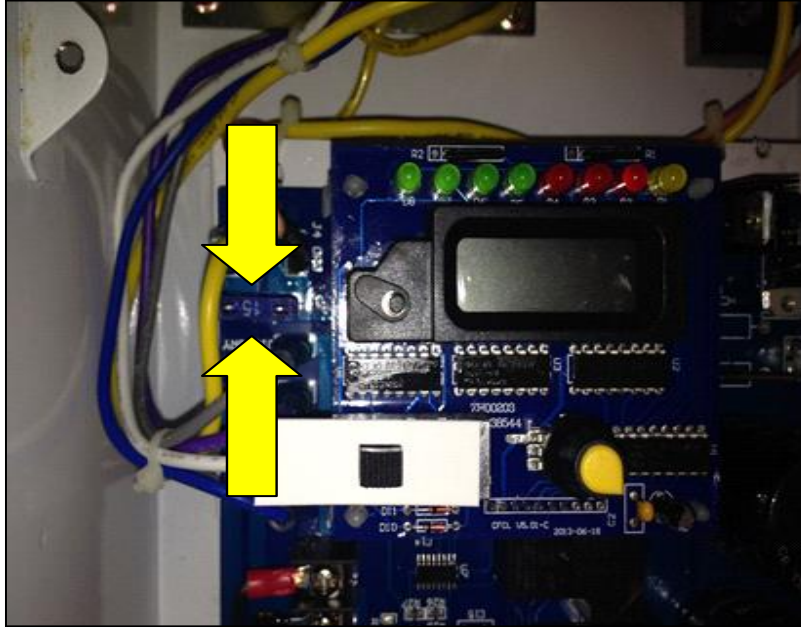

### 9. Improper Voltage:

- If the Control Module is configured to accept 220V, and is only connected to 110V, the system will appear to power on, but will not be operational or be able to read salinity or create chlorine. The Check Cell and Check Salt light may remain illuminated. In the System Status menu, the voltage may read approximately 10.0 - 13.0.
- Warning:** If the Control Module is configured to accept 110V, but is connected to 220V, this may cause severe damage or harm.
- See diagram below for the Control Module's internal voltage configuration. This can also be found on the inside of the door of your Control module.

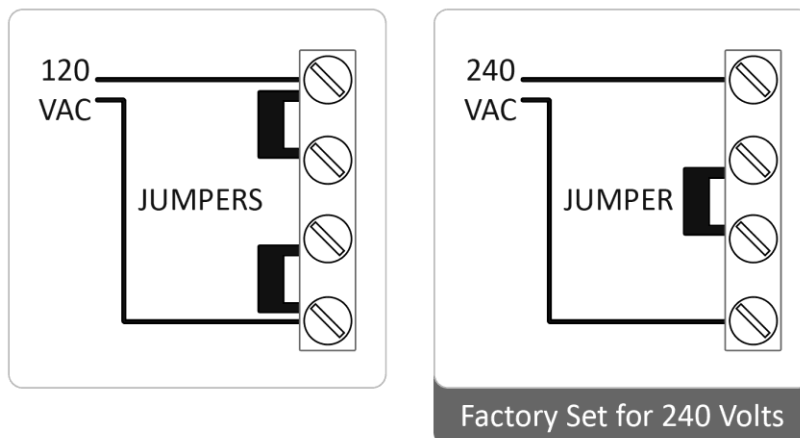

## How to Clean the Electrolytic Cell

The Electrolytic Cell has the self-cleaning Reverse Polarity feature built-in, which prevents mineral deposits from forming rapidly. However, the Cell may eventually need to be manually cleaned. The frequency of mineral build-up is dependent upon the balance of the pool's water chemistry, specifically the Saturation Index (see page 5).

In most circumstances, the Check Cell LED indicator will be illuminated solidly when the cell needs to be cleaned.

Follow these steps to clean the cell:

1. Turn all power to the filter system and salt system off. Close return line valves if applicable.
2. Completely disconnect the Cell Cord from the Control Module.
3. Unscrew the two threaded collars at the inlet and outlet side of the cell.
4. Remove cell from the return line.
5. **IMPORTANT:** Using gloves and eye protection during this process is recommended. Always add acid to the water, never water to the acid.
6. In a separate bucket, mix a solution of: one part Muriatic Acid and five parts water.
7. There are two different ways to clean the cell.
  - a. Use the End Cap plug (sold separately) to cap off then outlet side of the cell and pour the solution into the top of the cell.
    - i. Secure cell and let it soak for 5-10 minutes.
    - ii. See picture below on left.
    - iii. The end cap can be purchased at [www.circupool.com](http://www.circupool.com).
  - b. Submerge the cell in a bucket of the solution.
    - i. Make sure the cell cable is not submerged in water.
    - ii. Make sure the water line covers the internal components of the cell.
    - iii. Clamp the cell/cord in place so that it can remain in place safely for 5-10 minutes.
    - iv. See picture below on right
8. You will notice a fizzing or fogging effect inside the cell once the solution has made contact with the titanium cell, this is normal. The solution should completely cover the titanium plates, and should be allowed to soak for no longer than 10 minutes.
9. Dispose of the solution and wash out any remaining debris.

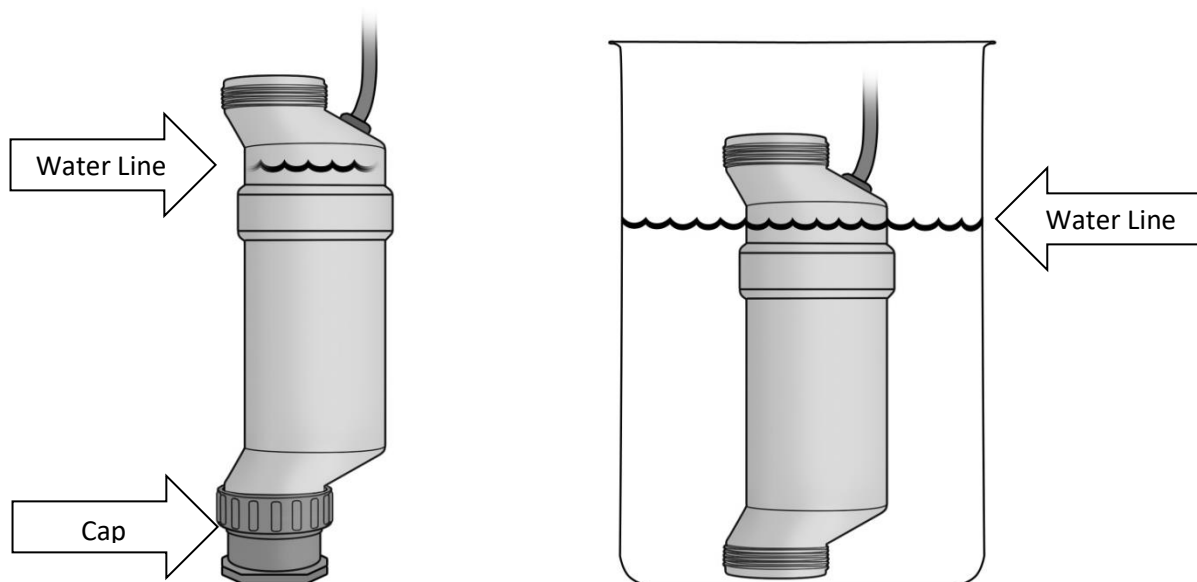

## How to Install the LCD Display Circuit Board

**WARNING** - ALWAYS MAKE SURE THE INPUT POWER IS COMPLETELY DISCONNECTED BEFORE ATTEMPTING ANY TROUBLESHOOTING PROCEDURES. ALL TROUBLESHOOTING SHOULD BE DONE BY A QUALIFIED PROFESSIONAL.

### Installation Steps:

1. Open the front cover door and remove the 2 screws from the left and right of the front panel to expose the Display Circuit Board.

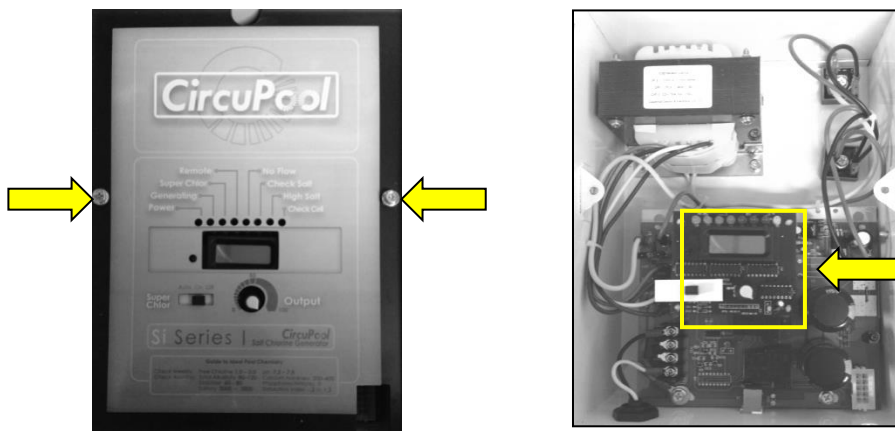

2. Use needle nose pliers to disconnect the 4 plastic holders by gently squeezing each side as shown in the picture below.

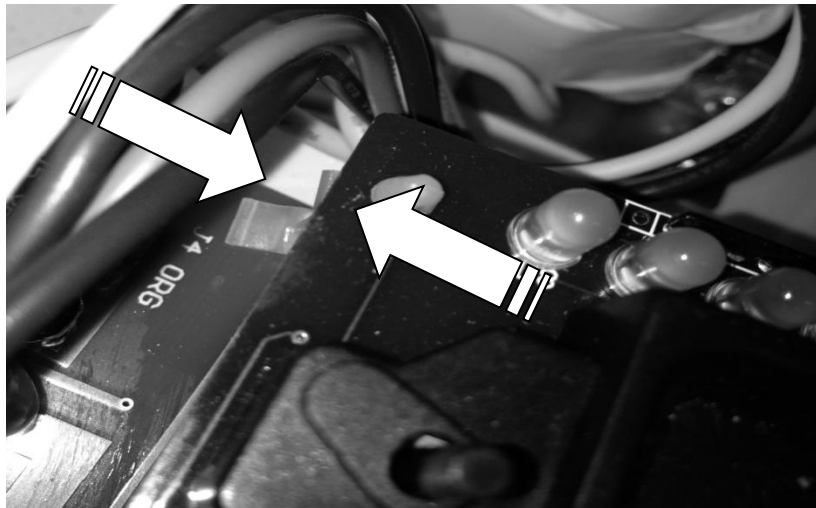

3. Gently lift the Display PCB off of the 4 plastic holders and the connecting needles.
4. Position new Display PCB on the connecting needles.
5. Position all 4 plastic holders.
6. Gently press down on the new Display PCB to lock it in place.
7. Turn on Si module to verify proper installation and power.
8. Reconnect front panel with the screws.

## How to Install the Flow Switch

**WARNING** - ALWAYS MAKE SURE THE INPUT POWER IS COMPLETELY DISCONNECTED BEFORE ATTEMPTING ANY TROUBLESHOOTING PROCEDURES. ALL TROUBLESHOOTING SHOULD BE DONE BY A QUALIFIED PROFESSIONAL.

Installation Steps for installing a Flow Switch into existing equipment:

1. Disconnect the flow switch wire from the Si control box.

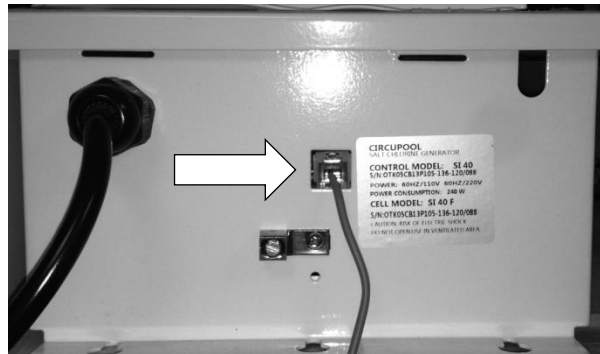

2. Turn the top of the Flow Switch counter clockwise until the switch is loose enough to pull out of the PVC fitting.

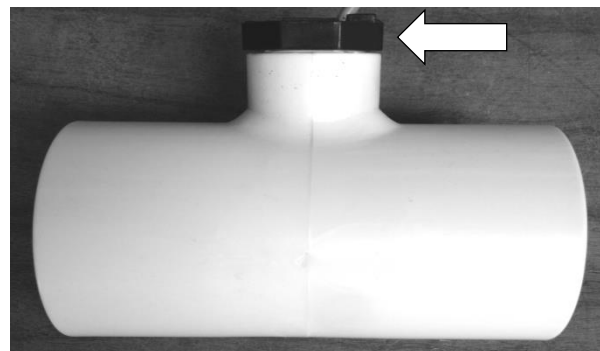

3. Install new flow switch and twist it clockwise to tighten. Make sure the directional arrow is facing the same direction as the water flow. Additional Teflon tape can be added to the threads to ensure a tight water seal.

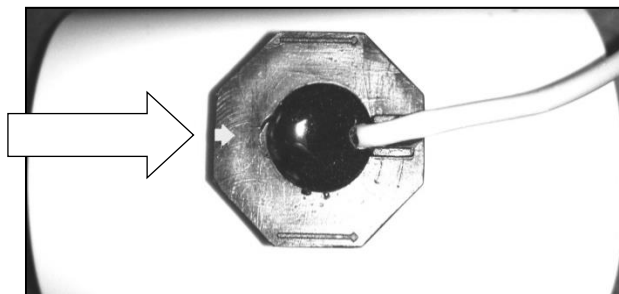

## How to Install Temperature / Flow Switch

**WARNING** - ALWAYS MAKE SURE THE INPUT POWER IS COMPLETELY DISCONNECTED BEFORE ATTEMPTING ANY TROUBLESHOOTING PROCEDURES. ALL TROUBLESHOOTING SHOULD BE DONE BY A QUALIFIED PROFESSIONAL.

This part replaces a standard Flow Switch and includes a temperature sensor, which can be used if accurate temperature readings are no longer being provided by the Cell.

1. Replace the original flow switch. This part is threaded into your PVC plumbing (see “How to Install the Flow Switch”).
2. Verify that equipment has no power, then remove the two screws from the front of the Control Module, and remove the faceplate cover.
3. Locate the three gold pins just above and slightly to the left of the light grey terminal where the flow switch plug gets connected on the lower portion of the main circuit board (see arrows in picture below). You will see a small black plastic jumper connecting two of the three pins. Move this plastic spacer one space over to left.
4. Put the front faceplate and screws back on.

